

NEW

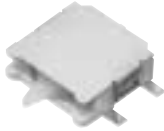

FEATURES

• Detect laterally in two directions with a single switch

With two 1a type contacts built-in to one switch, it is possible to detect laterally in two directions.

• Ultra compact and slim for space saving

The size, at 5.0 mm (W)×5.0 mm (L)×1.4 mm (H) .197 inch (W)×.197 inch (L)×.055 inch (H), is ultra compact and slim.

By using an FT-2Way switch to replace where two 1a type contact switches were used up to now, it is possible to reduce mounting space.

(Move from having two switches to having one.)

• Supports low level loads with twin gold plate contacts

The use of twin gold plate contacts means that low level loads of even 5μA 5V DC can be handled.

Contact reliability is also very high. Also, its ability to withstand ambient conditions has been greatly improved (anti-corrosiveness and resistance to humidity), so it will contribute to the performance of, especially, mobile equipments.

TYPICAL APPLICATIONS

1. Digital audio visual equipment

DVC (digital video camera)
DSC (digital still camera)

2. Digital compact equipment

Mobile phone, PDA, IC recorder, MD silicon audio

3. Personal computer and its peripherals

Notebook PC, CD-R/RW, DVD

4. Others

IC card and other electronic moneyrelated products

ORDERING INFORMATION

Ex. ABC 3 - 1 - - -

Type of switch	Contact arrangement	Positioning boss	Terminal shape	Packing style
3: FT-2Way switches	1: Right (1 Form A) Left (1 Form A)	0: Without positioning boss 1: With positioning boss	1: Straight terminal type 2: J bent terminal type	P: Embossed tape packing

PRODUCT LINEUP

Detection direction	Packing style	Straight terminal type		J bent terminal type	
		With positioning boss	Without positioning boss	With positioning boss	Without positioning boss
	Emboss tape (3,000 pcs./reel)	ABC3111P	ABC3101P	ABC3112P	ABC3102P

SPECIFICATIONS

1. Contact rating

5μA to 10mA 5V DC (resistive load)

CIRCUIT CONSTRUCTION

• N.O. (1 Form A)

Left operating direction

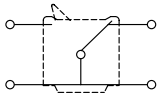

Right operating direction

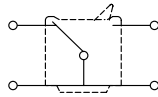

EMBOSS TAPE AND REEL

• Tape dimensions (Conforming to JIS C 0806-1995)

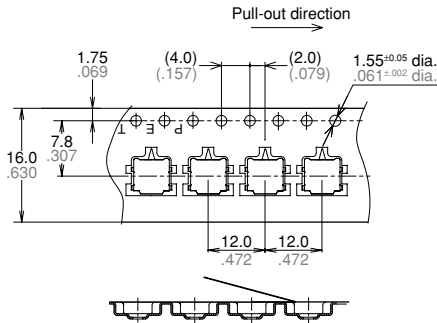

• Reel dimensions (Conforming to JIS C 0806-1995)

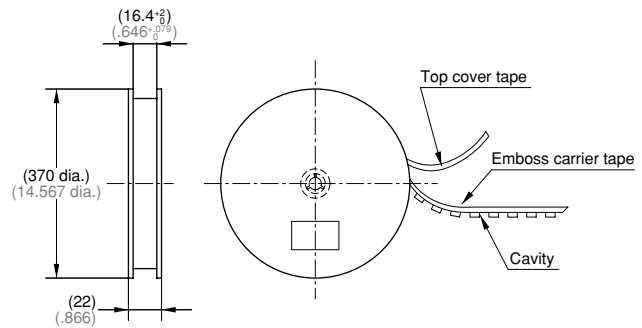

NOTES

1. Mounting

- 1) The positioning of the switch should be such that the pushbutton for the switch should not directly apply force to the operating section in the free condition.
- 2) During both mounting and operation, care must be taken to protect the pushbutton from excessive stress, as this may cause malfunctioning.
- 3) During mounting, the insulation distance between ground and each terminals/cover should be confirmed as sufficient.

2. Soldering

1) Reflow soldering

- Please use our recommended land pattern when cream-solder printing.
- For cream soldering; Screen thickness is recommended between 0.10 to 0.15 mm .006 to .008 inch.

• As this switch is thin, using flux should be avoided for the reason of the flux may come inside of the switch and cause damage.

• Please use the reflow temperature profile conditions recommended below for reflow soldering.

(The temperature is the one measured on the surface of the PCB.)

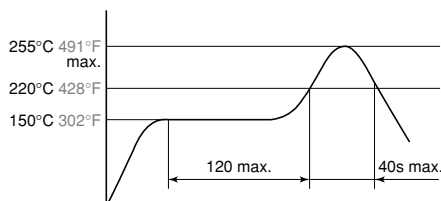

• Please keep the number of reflows to no more than two.

• Please consult us if you plan to use N₂ reflow.

• Please avoid excessive oven temperatures and long reflow times as this can lead to deterioration of switch characteristics.

(Reworking of soldered sections)

• Please complete reworking in one session.

• Keeping contact to within 3 s, use an 18 W soldering iron at a temperature of 320°C 608°F maximum.

• Please avoid using a soldering iron of excessive wattage and tip temperature, and avoid excessive soldering times, because this may lead to deterioration of switch characteristics.

• Please be careful and avoid applying force on the terminals while soldering. This can cause deformation that may lead to improper operation.

2) Hand soldering

• If hand soldering will be one of the processes, choose the J-bend terminal type, if at all possible. This type is constructed to make it difficult for the flux to enter the unit when hand soldering.

• For land patterns, please use the ones recommended by us.

J-bend terminal type

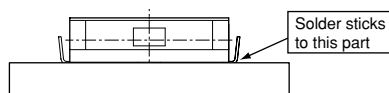

• Keeping contact to within three seconds, use an 18 W soldering iron at a temperature of 320°C 608°F maximum.

• Please avoid using a soldering iron of excessive wattage and tip temperature, and avoid excessive soldering times, because this may lead to deterioration of switch characteristics.

• Please be careful and avoid applying force on the terminals while soldering. This can cause deformation that may lead to improper operation.

3. Switch operations

1) When setting the activating unit that will operate the switch so that it will operate laterally 13° to 48° from the center position or when converting the distance, please set so that pressing will be 1.1 mm or more from the center position.

2) Avoid using the switch as a stopper since it may cause trouble with the operations.

3) Please make the angle dimensions of the switch activating unit the same or greater than R1.

4) Regarding ON-OFF operation timing, please push all the way to the set position without lingering in the OP vicinity.

4. Environment

1) These switches do not have a sealed construction. As such, the construction of the equipment in which the switches are to be installed should be given careful consideration when the switches are to be used in locations where corrosive gases, silicon or other substances which will adversely affect the contacts are used,

where there is a high concentration of dust or where the switches may be exposed to condensation or water. Using switches in locations like these may cause malfunctioning.

2) Avoid using this switch in high-temperature, high-humidity or condensation-forming environments and avoid allowing droplets of water to remain on the switch or come into contact with it. These conditions may interfere with the performance of the switch (resulting in short-circuiting, etc.). Use the type with the gold contacts in applications involving trains, aircraft, motor vehicles or medical equipment where the switch must satisfy safety and high reliability requirements. Please consult with us for the applications required high reliability.

3) Because the humidity range differs depending on the ambient temperature, the humidity range indicated below should be used. Continuous operation of the switch is possible within this range, but continuous use near the limit of the range should be avoided.

4) This humidity range does not guarantee permanent performance.

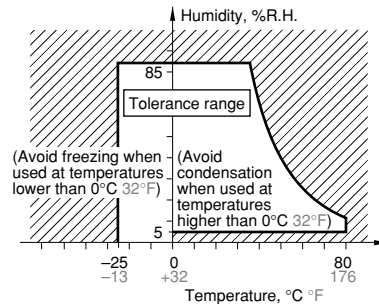

5. Breakdown mode

For the switch breakdown mode, shorts, open circuits, or rises in temperature should be considered. For a device to be safe so that it does not create any adverse effect, ensure that a protection circuit or protection device is in place to protect against a possible switch failure. Also, please make sure that sufficient redundancy is built into the system in order to ensure safety.