

RX-LS200

Amplifier Built-in Adjustable Range & Fixed-focus Reflective Photoelectric Sensor

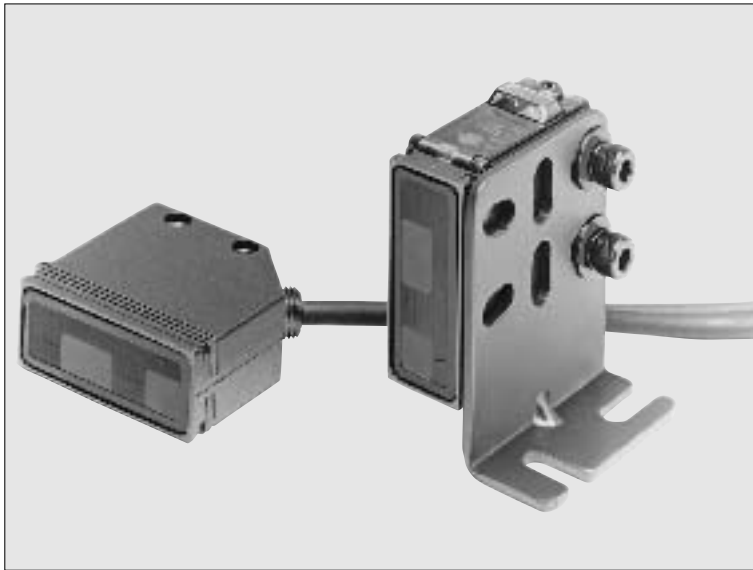

Detection of Different Color Objects at a Certain Distance

CE Marked
Conforming to EMC Directive

Not Affected by Color

The color or size of the object does not affect its sensing.

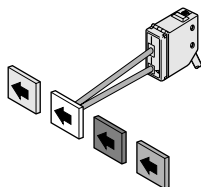

Not Affected by Background

The sensor does not detect the background beyond the set distance since it is distance settable type.

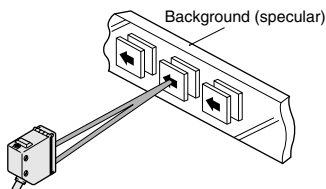

Insusceptible to Dust

The sensing performance is less affected by dust as it does not depend on the incident light intensity.

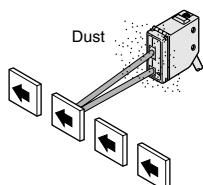

Waterproof

The sensor can be hosed down because of its IP67 construction. The equipment on which the sensor is mounted can be washed without any problem.

Note: However, take care that if it is exposed to water splashes during operation, it may detect a water drop itself.

Robust

Its robust enclosure is made of die-cast zinc alloy.

High-speed Response Time: 1ms

It can be used on a high speed assembly line.

Principle of Optical Sensing

Adjustable Range & Fixed-focus Reflective Type

The sensing range for which the sensor detects an object is determined by the incident beam angle, regardless of the incident light intensity.

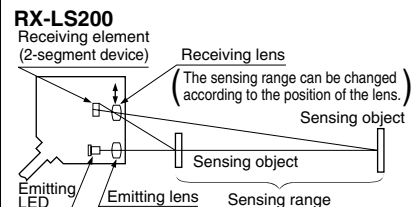

Convergent Reflective Type

The sensor detects an object only in the overlapping area of the emitting and receiving envelopes. The detectability is a little influenced by the reflectivity of the object surface.

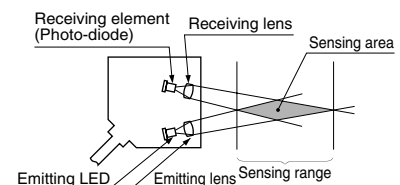

Diffuse Reflective Type

The sensing range changes with the reflectivity and size of the sensing object.

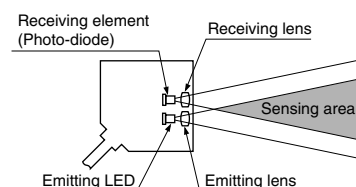

RX-LS200

APPLICATIONS

Detecting lids of cups

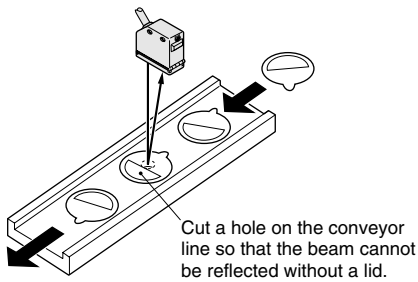

Safekeeping at parking garage

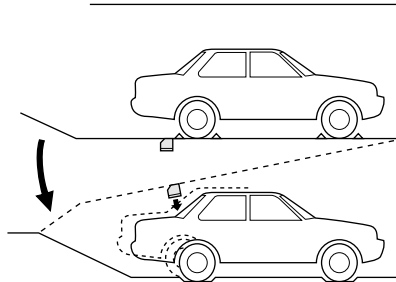

Wafer counting in cassette

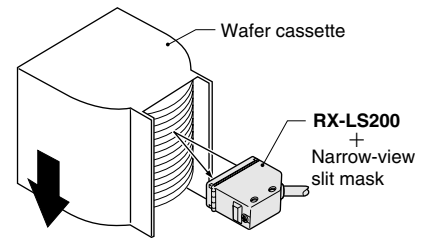

ORDER GUIDE

Appearance	Sensing range	Model No.	Output
	50 to 200mm	RX-LS200	NPN open-collector transistor
		RX-LS200-P	PNP open-collector transistor

OPTIONS

Designation	Model No.	Description	
Narrow-view slit mask	OS-RXL-1	Slit size	2.5 × 24mm
	OS-RXL-2		3.0 × 24mm
	OS-RXL-3		3.5 × 24mm
Protective tube	PT-RX500	Length	500mm
	PT-RX1000		1,000mm

Narrow-view slit mask

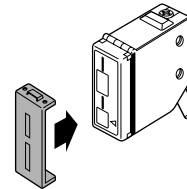

Protective tube

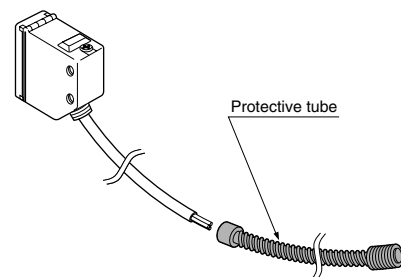

RX-LS200

SPECIFICATIONS

Item	Model No.	Adjustable range & fixed-focus reflective	
		NPN output type	PNP output type
		RX-LS200	RX-LS200-P
Sensing range	50 to 200mm with white non-glossy paper (50 × 50mm)		
Hysteresis	10% or less of operation distance		
Repeatability	Along sensing axis: 1mm or less, Perpendicular to sensing axis: 0.5mm or less		
Supply voltage	12 to 24V DC ± 10% Ripple P-P 10% or less		
Current consumption	40mA or less		
Output	NPN open-collector transistor		PNP open-collector transistor
	<ul style="list-style-type: none"> • Maximum sink current: 100mA • Applied voltage: 30V DC or less (between output and 0V) • Residual voltage: 1.5V or less (at 100mA sink current) 0.4V or less (at 16mA sink current) 		<ul style="list-style-type: none"> • Maximum source current: 100mA • Applied voltage: 30V DC or less (between output and +V) • Residual voltage: 1V or less (at 100mA source current) 0.4V or less (at 16mA source current)
	Utilization category	DC-12 or DC-13	
	Output operation	Switchable either Light-ON or Dark-ON	
Short-circuit protection	Incorporated		
Response time	1ms or less		
Operation indicator	Red LED (lights up when the output is ON)		
Stability indicator	Green LED (lights up under stable light received condition or stable dark condition)		
Distance adjuster	2-turn mechanical adjuster		
Environmental resistance	Pollution degree	3 (Industrial environment)	
	Protection	IP67 (IEC)	
	Ambient temperature	- 25 to + 60°C (No dew condensation or icing allowed), Storage: - 30 to + 70°C	
	Ambient humidity	35 to 85% RH, Storage: 35 to 85% RH	
	Ambient illuminance	Sunlight: 11,000 lx at the light-receiving face, Incandescent light: 3,500 lx at the light-receiving face	
	EMC	Emission: EN50081-2, Immunity: EN50082-2	
	Voltage withstandability	1,000V AC for one min. between all supply terminals connected together and enclosure	
	Insulation resistance	20MΩ, or more, with 250V DC megger between all supply terminals connected together and enclosure	
	Vibration resistance	10 to 500Hz frequency, 1.5mm amplitude (10G max.) in X, Y and Z directions for two hours each	
Shock resistance	500m/s ² acceleration (approx. 50G) in X, Y and Z directions for three times each		
Emitting element	Infrared LED (modulated)		
Material	Enclosure: Die-cast zinc alloy, Indicator cover: Polyethersulphone, Lens: Polycarbonate		
Cable	0.15mm ² 3-core oil, heat and cold resistant cable, 3m long		
Cable extension	Extension up to total 100m is possible with 0.3mm ² , or more, cable.		
Weight	85g approx.		
Accessories	MS-RX-1 (Sensor mounting bracket): 1 set, Adjusting screwdriver: 1 No.		

I/O CIRCUIT AND WIRING DIAGRAMS

RX-LS200 NPN output type

I/O circuit diagram

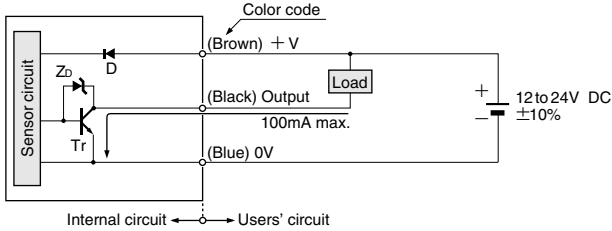

Symbols ... D: Reverse supply polarity protection diode
Zb: Surge absorption zener diode
Tr: NPN output transistor

Wiring diagram

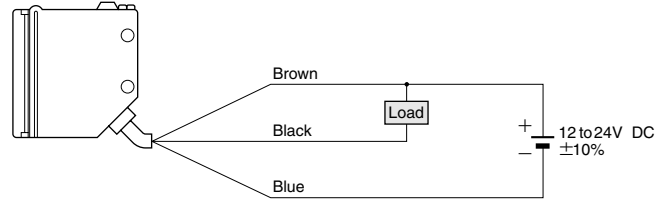

RX-LS200-P PNP output type

I/O circuit diagrams

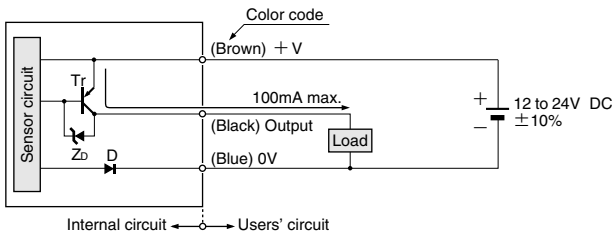

Symbols ... D: Reverse supply polarity protection diode
Zb: Surge absorption zener diode
Tr: PNP output transistor

Wiring diagram

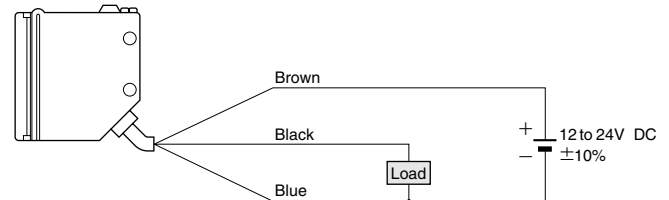

SENSING CHARACTERISTICS (TYPICAL)

Sensing fields

- Setting distance: 200mm (Horizontal)

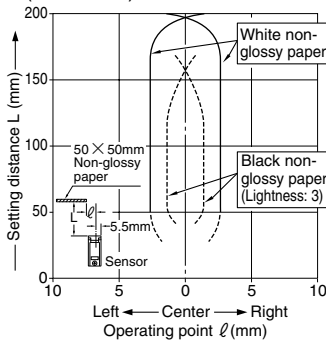

- Setting distance: 200mm (Vertical)

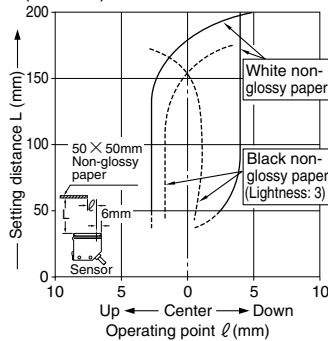

- Setting distance: 150mm (Horizontal)

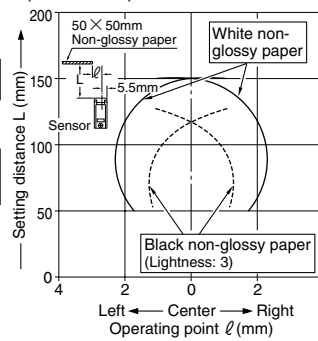

- Setting distance: 150mm (Vertical)

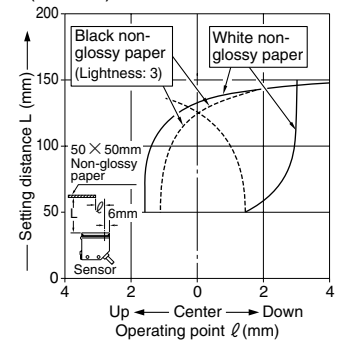

- Setting distance: 150mm with slit mask (Horizontal)

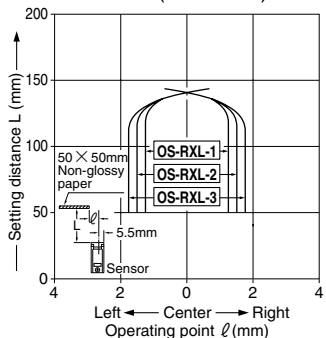

- Setting distance: 150mm with slit mask (Vertical)

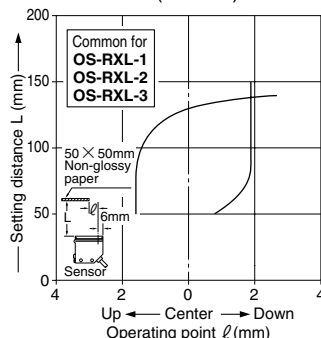

RX-LS200

SENSING CHARACTERISTICS (TYPICAL)

Correlation between sensing object size and sensing range

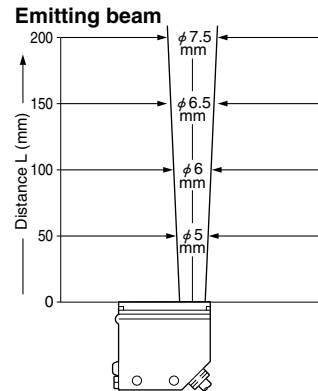
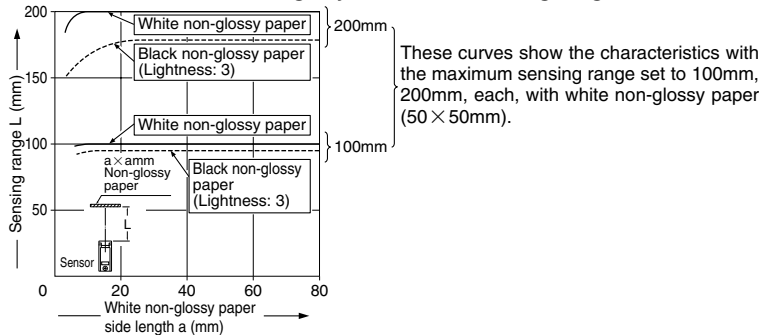

Correlation between material (50 × 50mm) and sensing range

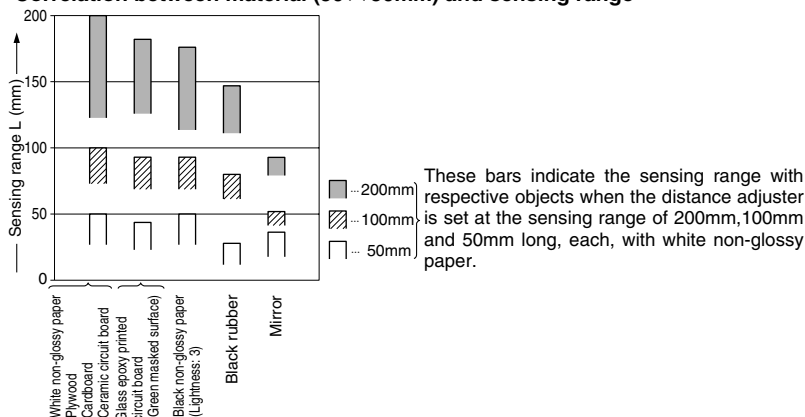

PRECAUTIONS FOR PROPER USE

This product is not a safety sensor. Its use is not intended or designed to protect life and prevent body injury or property damage from dangerous parts of machinery. It is a normal object detection sensor.

Mounting

- The tightening torque should be 1.17N·m or less.

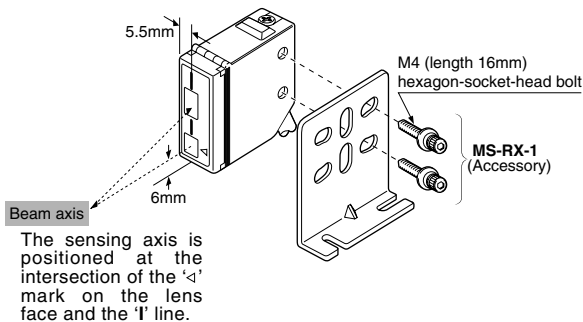

- Care must be taken regarding the sensor mounting direction with respect to the object's direction of movement.

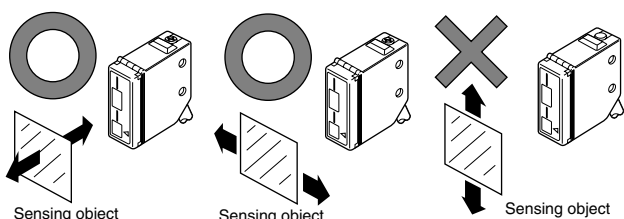

Do not make the sensor detect an object in this direction because it may cause unstable operation.

- When detecting a specular object (aluminum or copper foil) or an object having a glossy surface or coating, please take care that there are cases when the object may not be detected due to a small change in angle, wrinkles on the object surface, etc.
- When a specular body is present below the sensor, use the sensor by tilting it slightly upwards to avoid wrong operation.
- If a specular body is present in the background, wrong operation may be caused due to a small change in the angle of the background body. In that case, install the sensor at an inclination and confirm the operation with the actual sensing object.
- Do not install the sensor at a distance of less than 50mm from the object because the sensing is unstable in this range.

Wiring

- The output of **RX-LS200-P** is not incorporated with a short-circuit protection circuit. Do not connect it directly to a power supply or a capacitive load.

Others

- Do not use during the initial transient time (50ms) after the power supply is switched on.

PRECAUTIONS FOR PROPER USE

Distance adjustment

<Adjusters>

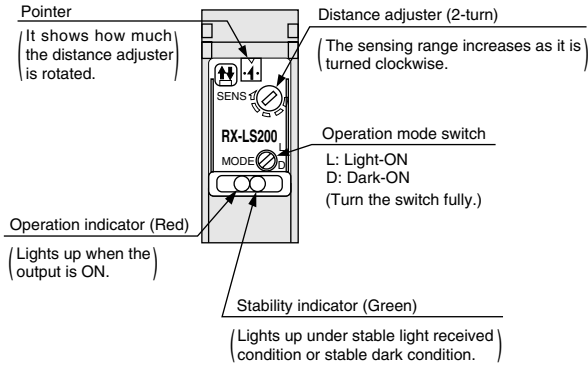

<Adjusting procedure>

Step	Description	Distance adjuster
①	Turn the distance adjuster fully counterclockwise to the minimum sensing range position (50mm approx.). (Do not turn excessively.)	Turn
②	Place an object at the required distance from the sensor, turn the distance adjuster gradually clockwise, and find out point (A) where the sensor changes to the light received condition.	
③	Remove the object, turn the distance adjuster further clockwise, and find out point (B) where the sensor changes to the light received condition again with only the background. (When the sensor does not go to the light received condition even if the adjuster is fully turned clockwise, point (B) is this extreme point.)	
④	The optimum position to stably detect objects is the center point between (A) and (B)	Optimum position

DIMENSIONS (Unit: mm)

RX-LS200 RX-LS200-P Sensor

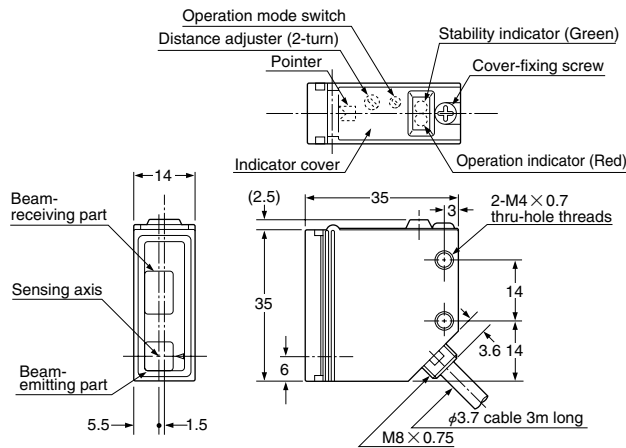

PT-RX500 PT-RX1000 Protective tube (Optional)

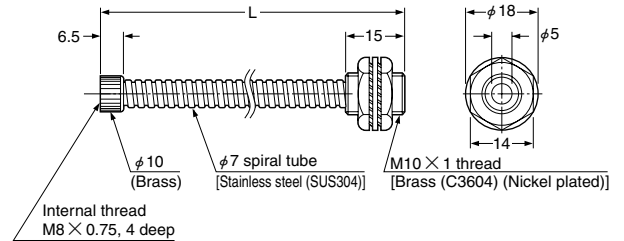

· Length L

Model No.	L (mm)
PT-RX500	500 ⁺¹⁰ ₀
PT-RX1000	1,000 ⁺¹⁰ ₀

MS-RX-1 Sensor mounting bracket (Accessory)

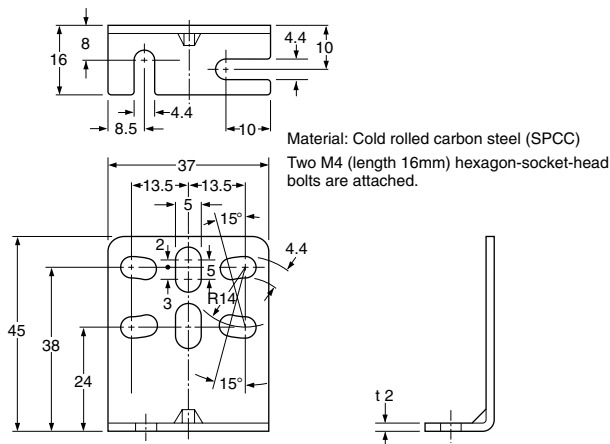

Assembly dimensions

