

Small size

AJ7 switch 10A type
Standard actuator

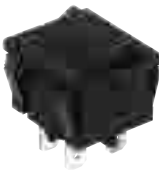

AJ7 switch 10A type
Wide actuator



AJ7 switch 6A type



RoHS Directive compatibility information
<http://www.nais-e.com/>

FEATURES

1. Power rocker switches for safety requirements.

- All versions comply with ClassII EN61058-1 insulation grade.
Insulation distance: 8mm Min.
Contact gap: 3mm Min.

¥ International Standard-approved status

		Already approved
AJ7 switch 10A type	Standard actuator type	UL, CSA, VDE, TÜV, ÖVE, KEMA, SEMKO, NEMKO, DEMKO, FIMKO, SEV
	Wide actuator type	UL, CSA, VDE, TÜV, SEMKO, NEMKO, DEMKO, FIMKO, SEV, KEMA, ÖVE
AJ7 switch 6A type		UL, CSA, TÜV

2. High inrush current resistance is ideal for office automation equipment.

Type	Inrush	Contact rating	Expected life
10A type	100A	10A 250V AC	Min.10 ⁴
6A type	60A	6A 250V AC	

3. Operation that only requires a light touch

The best operation characteristics were sought by analyzing touch data gathered by monitoring 1,500 people.

- Power Rocker Switch touch curve

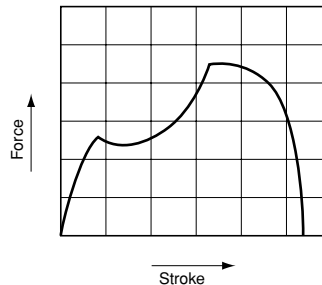

4. A broad product line

The AJ7 switches are available with five different types of terminals: quick-connect terminals, soldering terminals, PC board terminals, right angle terminals and left angle terminals.

5. Eight standard actuator colors

White, black, red, dark gray, light gray, blue, green, yellow

6. Cadmium-free contact compatibility.

PRECAUTIONS WHEN USING CADMIUM-FREE CONTACT TYPE

Models with cadmium-free contacts have been introduced in order to reduce environmentally harmful substances. ("F" is affixed to the end of the part number.) We ask customers who are currently using products with cadmium-containing contacts (no "F" at the end of the part number) to please make the switch to models with cadmium-free contacts. When switching, operating life may differ depending on the load. Please be sure to verify this by conducting an evaluation using actual equipment.

CONSTRUCTION

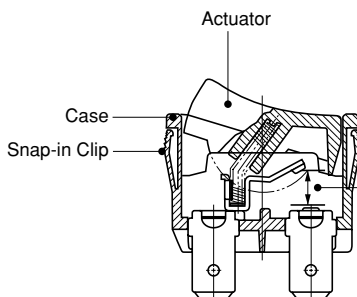

Contact gap (more than 3mm)

The EN60950 (intended for office automation equipment) conforms with a 3mm gap. When directly opening or closing the primary power supply side, a contact gap of at least 3mm is required in order to ensure safety.

AJ7 (J7)

ORDERING INFORMATION

AJ 7 [] [] [] [] [] [] [] [] F

7: AJ7 switch

Rating & size of actuator

Nil: 10A standard size

W: 10A wide size

6: 6A standard size

Number of poles and Operation

1: 1-pole, single throw (ON-OFF)

2: 2-pole, single throw (ON-OFF)

Terminal shape

0: .187 Quick-connect terminal

1: Soldering terminal

2: PC board terminal

3: PC board right angle terminal (for standard actuator only)

4: PC board left angle terminal (for standard actuator only)

Actuator indication

0: No indication

3:  indication (Side indication)

1:  indication (Indication on top)

4:  indication (Indication on top)

2:  indication (Indication on top)

5:  indication (Side indication)

Actuator color ^{Remark 1)}

W: White B: Black R: Red Z: Dark gray H: Light gray L: Blue G: Green Y: Yellow

Flange color

Nil: Black (standard color)

(Custom ordered color: W: White, R: Red, Z: Dark gray, H: Light gray, L: Blue, G: Green, Y: Yellow) ^{Remark 1, 5)}

Insulation guard

Nil: Short guard type

T: Long guard type (.187 Quick-connect terminal and soldering terminal only)

F: Cadmium-free product

Remarks: 1. The 10A type has indication on the actuator.

2. The correspondence between actuator colors and flange colors marked with an asterisk differs according to the type; refer to the remark for the PRODUCT TYPES.

3. "I O" is engraved on all flanges.

4. The color of indication on the actuator:

- White actuator: black
- Others: white

5. The flange color of 6A type is black only.

ACTUATOR INDICATIONS ON PRODUCTS MADE TO ORDER

With indication on top

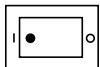

With side indication

(When the "I" indication is visible on the side of the actuator, it indicates that the switch is in the "ON" state.)



With  indications:

The I and O symbols are located on each side, respectively.

With  indications:

The I symbol is located on the side.

PRODUCT TYPES

1. 10 A type

1) Standard actuator type

(1) Without indication on actuators

Terminal shape	Poles	Operating types	Part No.	
			Without indication	
.187 Quick-connect terminal	1-pole	ON-OFF	AJ7100*F	
	2-pole		AJ7200*F	
Soldering terminal	1-pole		AJ7110*F	
	2-pole		AJ7210*F	
PC board terminal	1-pole		AJ7120*F	
	2-pole		AJ7220*F	
PC board right angle terminal	1-pole		AJ7130*F	
	2-pole		AJ7230*F	
PC board left angle terminal	1-pole		AJ7140*F	
	2-pole		AJ7240*F	

- Remarks: 1. A letter indicating the actuator color is entered in place of asterisk. (W: White, B: Black, R: Red, Z: Dark gray, H: Light gray, L: Blue, G: Green, and Y: Yellow). Standard flange color is black. For other colors type, they are custom ordered. For requests of other flange color, please enter the following letter before the "F" in the part number. (W: White, R: Red, Z: Dark gray, H: Light gray, L: Blue, G: Green and Y: Yellow)
2. Long guard type is available for .187 Quick-connect terminal and soldering terminal type. When ordering, please add a "T" before the "F" at the end of the part number.
3. The color of indication on the actuator:
- For white actuator: black
 - For others: white
4. They come with a stamp indicating international standards without your request.
5. Note that the position of the I mark on the flange is used as a reference for left angle and right angle terminals as shown in the diagram below. This also applies to the 6A type.

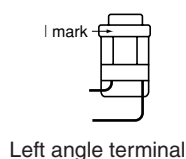
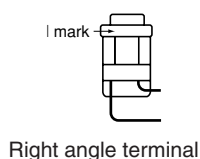

(2) With indication on actuators

Terminal shape	Poles	Operating types	Part No.	
			With I ○ indication	With — ○ indication
.187 Quick-connect terminal	1-pole	ON-OFF	AJ7101*F	AJ7102*F
	2-pole		AJ7201*F	AJ7202*F
Soldering terminal	1-pole		AJ7111*F	AJ7112*F
	2-pole		AJ7211*F	AJ7212*F
PC board terminal	1-pole		AJ7121*F	AJ7122*F
	2-pole		AJ7221*F	AJ7222*F
PC board right angle terminal	1-pole		AJ7131*F	AJ7132*F
	2-pole		AJ7231*F	AJ7232*F
PC board left angle terminal	1-pole		AJ7141*F	AJ7142*F
	2-pole		AJ7241*F	AJ7242*F

- Remarks: 1. A letter indicating the actuator color is entered in place of asterisk. (W: White, B: Black, R: Red, Z: Dark gray, H: Light gray, L: Blue, G: Green, and Y: Yellow). Standard flange color is black. For other colors type, they are custom ordered. For requests of other flange color, please enter the following letter before the "F" in the part number. (W: White, R: Red, Z: Dark gray, H: Light gray, L: Blue, G: Green and Y: Yellow)
2. Long guard type is available for .187 Quick-connect terminal and soldering terminal type. When ordering, please add a "T" before the "F" at the end of the part number.
3. The color of indication on the actuator:
- For white actuator: black
 - For others: white
4. They come with a stamp indicating international standards without your request.
5. Note that the position of the I mark on the flange is used as a reference for left angle and right angle terminals as shown in the diagram below. This also applies to the 6A type.

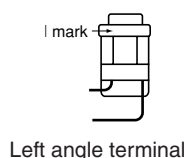
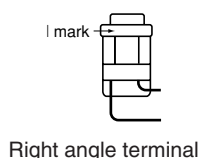

AJ7 (J7)

2) Wide actuator type

(1) Without indication on actuators

Terminal shape	Poles	Operating types	Part No.	
			Without indication	
.187 Quick-connect terminal	1-pole	ON-OFF	AJ7W100*F	
	2-pole		AJ7W200*F	
Soldering terminal	1-pole		AJ7W110*F	
	2-pole		AJ7W210*F	
PC board terminal	1-pole		AJ7W120*F	
	2-pole		AJ7W220*F	

(2) With indication on actuators

Terminal shape	Poles	Operating types	Part No.	
			With ○ indication	With — ○ indication
.187 Quick-connect terminal	1-pole	ON-OFF	AJ7W101*F	AJ7W102*F
	2-pole		AJ7W201*F	AJ7W202*F
Soldering terminal	1-pole		AJ7W111*F	AJ7W112*F
	2-pole		AJ7W211*F	AJ7W212*F
PC board terminal	1-pole		AJ7W121*F	AJ7W122*F
	2-pole		AJ7W221*F	AJ7W222*F

- Remarks: 1. A letter indicating the actuator color is entered in place of asterisk. (W: White, B: Black, R: Red, Z: Dark gray, H: Light gray, L: Blue, G: Green, and Y: Yellow).
Standard flange color is black. For other colors type, they are custom ordered. For requests of other flange color, please enter the following letter before the "F" in the part number. (W: White, R: Red, Z: Dark gray, H: Light gray, L: Blue, G: Green and Y: Yellow)
2. The color of indication on the actuator:
- For white actuator: black
 - For others: white
3. They come with a stamp indicating international standards without your request.

2. 6 A type

1) Standard actuator type

(1) Without indication on actuators

Terminal shape	Poles	Operating types	Part No.	
			Without indication	
.187 Quick-connect terminal	1-pole	ON-OFF	AJ76100*F	
	2-pole		AJ76200*F	
Soldering terminal	1-pole		AJ76110*F	
	2-pole		AJ76210*F	
PC board terminal	1-pole		AJ76120*F	
	2-pole		AJ76220*F	
PC board right angle terminal	1-pole	AJ76130*F		
	2-pole	AJ76230*F		
PC board left angle terminal	1-pole	AJ76140*F		
	2-pole	AJ76240*F		

(2) With indication on actuators

Terminal shape	Poles	Operating types	Part No.	
			With ○ indication	With — ○ indication
.187 Quick-connect terminal	1-pole	ON-OFF	AJ76101*F	AJ76102*F
	2-pole		AJ76201*F	AJ76202*F
Soldering terminal	1-pole		AJ76111*F	AJ76112*F
	2-pole		AJ76211*F	AJ76212*F
PC board terminal	1-pole		AJ76121*F	AJ76122*F
	2-pole		AJ76221*F	AJ76222*F
PC board right angle terminal	1-pole	AJ76131*F	AJ76132*F	
	2-pole	AJ76231*F	AJ76232*F	
PC board left angle terminal	1-pole	AJ76141*F	AJ76142*F	
	2-pole	AJ76241*F	AJ76242*F	

(Standard color is black. For other color type, they are custom ordered.)

Remarks: 1. Replace the asterisk with a code that indicates the actuator color.

B: Black (standard), W: White (custom ordered), R: Red (custom ordered), Z: Dark gray (custom ordered), H: Light gray (custom ordered)

2. The color of | ○ indication on the actuator: White actuator: black Others: white

3. They come with a stamp indicating international standards without your request.

AJ7 (J7)

2. Soldering terminal

mm General tolerance: ± 0.5

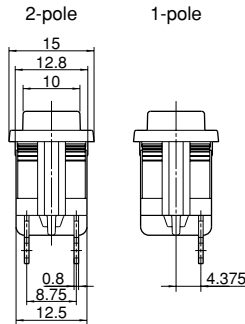
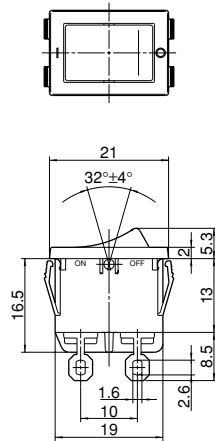

Long guard type
Soldering terminal

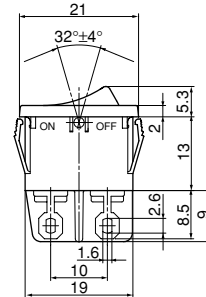
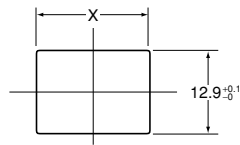

Diagram of recommended locations
for panel mounting holes



Panel thickness	X
0.75 to 1.25	$19.2^{+0}_{-0.1}$
1.25 to 2	$19.4^{+0}_{-0.1}$
2 to 3	$19.8^{+0}_{-0.1}$

3. PC board terminal

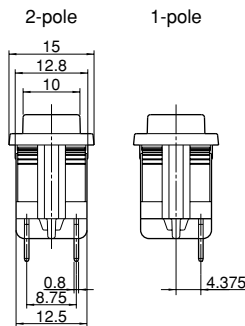
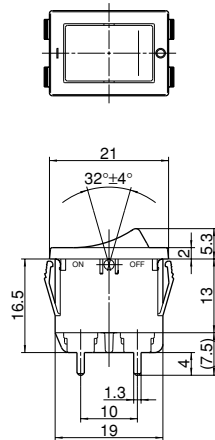
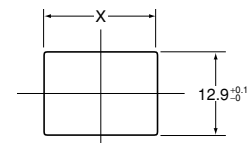
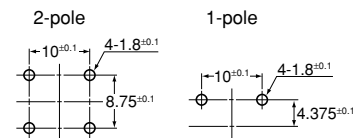

Diagram of recommended locations
for panel mounting holes



PC board pattern



Panel thickness	X
0.75 to 1.25	$19.2^{+0}_{-0.1}$
1.25 to 2	$19.4^{+0}_{-0.1}$
2 to 3	$19.8^{+0}_{-0.1}$

4. PC board right angle terminal

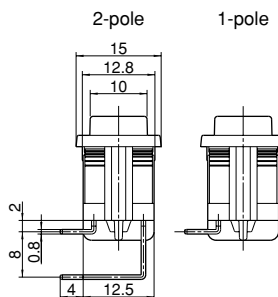
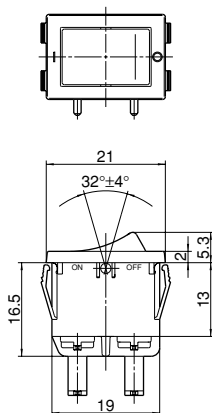
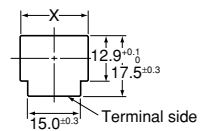
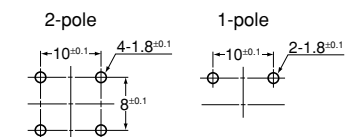

Diagram of recommended locations
for panel mounting holes



PC board pattern



Panel thickness	X
0.75 to 1.25	$19.2^{+0}_{-0.1}$
1.25 to 2	$19.4^{+0}_{-0.1}$
2 to 3	$19.8^{+0}_{-0.1}$

Remark: A type left angle terminals is also available.

5. Wide actuator type

mm General tolerance: ± 0.5 

Diagram of recommended locations for panel mounting holes



Panel thickness	X
1 to less than 1.8	19.2 ^{+0.1} _{-0.1}
1.8 to 2.3	19.9 ^{+0.1} _{-0.1}

Remark: Dimensions for the terminals of soldering terminal type and PC board terminal type are the same as those of standard size type.

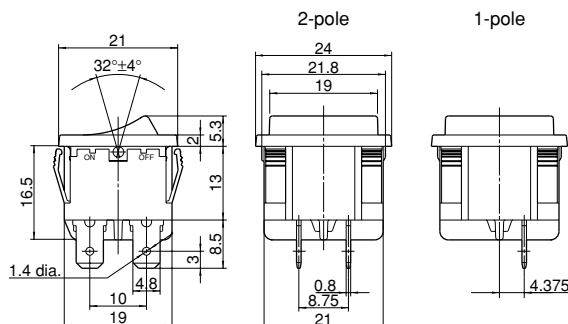
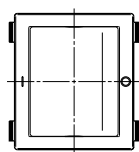
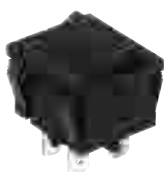
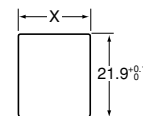
NOTES

1. Switch mounting

Mount the switch with the hole cutting dimensions shown in the dimensions. Contact us if you are considering using a panel of other than the recommended size and shape.

2. Regarding fastening lead wires to terminals

1) When connecting the tab terminals, use a .187 Quick-connect and insert the terminals straight in.

If they are skewed, the terminals will require excessive insertion force. In addition, there is some variation in the insertion force required for different receptacles from different manufacturers, so confirm how much force is needed under actual conditions.

Do not solder wires onto tab terminals.

2) With manual soldering: Complete the soldering connection work within 3 seconds with the tip of the soldering iron (60W soldering iron) at a temperature of 420°C or lower, and take care not to apply any force to the terminal area.

Avoid touching the switch with soldering iron.

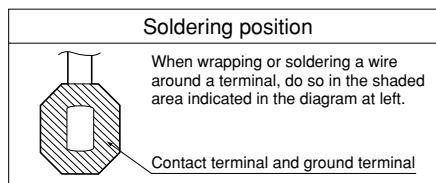

Refer to the diagram above, "soldering position," for details on the position where a wire should be soldered to a terminal. When soldering PC board terminals, keep soldering time to within 5 s at 270°C soldering bath or within 3 s at 350°C soldering bath.

3) The terminals should be connected in such a way that they are not under constant stress from the connecting wires.

4) Terminal material is copper alloy which may discolor due to finger's oil or after a long time. But that discoloration does not effect actual performance.

3. Resistance to chemicals

To clean the switch unit, use a neutral detergent diluted with water. Do not use acidic or alkaline solvents as they may damage the switch. Furthermore, be careful not to get any of the detergent solution inside of the switch while cleaning it.

4. Environment

Avoid using and storing these switches in a location where they will be exposed to corrosive gases, silicon, or high dust levels, all of which can have an adverse effect on the contacts.

5. Take care not to drop the product as it may impair performance.

REFERENCE

1. Outline of UL1054 test

Overload test AJ7: 12.5A 250V AC (Power factor 0.75 to 0.8)

50 operation

Endurance test AJ7: 10A 250V AC (Power factor 0.75 to 0.8)

6×10³ operation

After testing, temperature rise of terminals should be less than 30°C and no abnormality should be observed in characteristics.

2. Outline of EN61058-1 test

After switching 5×10^3 times on the below load condition at both 85⁺⁵°C and 25±10°C, temperature rise of terminals should be less than 55°C and no abnormality should be observed in characteristics.

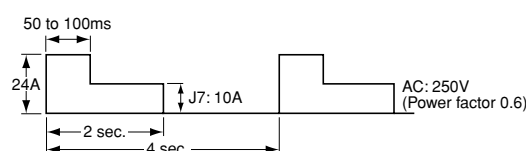

AJ7 (J7)

INTRODUCTION TO 4P CONNECTORS FOR THE AJ7 SWITCH (produced by Nippon Tanshi co., Ltd)



Suitable switches: AJ7 switch, .187 Quick-connect terminal

(Note: Terminal guard long type switches are not suitable for this connector.)

Housing

Product number: 4120-4204

Receptacle

Product number: 171901-M2

Notes) This AJ7 switch connector is not available from Matsushita Electric Works. Contact us for further details on this connector.